

DGN

Set-back vortex impeller

All product images are indicative only



General characteristics

Set-back vortex impeller	
motor power	1,1 ÷ 4,1 kW
poles	2 / 4 / 6
discharge	GAS 2½" vertical DN65÷DN150 horizontal
free passage	max 150 mm
max flow rate	46.4 l/s
max head	22.3 m

Electromechanical assembly

Electromechanical assembly in GJL-250 cast iron, for submerged operation. Seal set comprising 2 (two) opposing silicon carbide mechanical seals in inspectable oil sump. Ecological dry motor. Series available in ATEX explosion-proof version.

Applications

Used with unstrained soiled biological wastewaters and sewage and for civil lifting applications. It is thus ideal for wastewater treatment plants, sewer systems, livestock farms, industry and agriculture. This series is prefitted for installation of the ZENIT cooling system for dry or semi-submerged installation.

Construction materials

Case	Cast iron EN-GJL 250
Impeller	Cast iron EN-GJL-250
Nuts and bolts	Stainless steel - Class A2-70
Standard gasket	Rubber - NBR
Shaft	Stainless steel - AISI 420
Cooling jacket	Stainless steel - AISI 304
Paint type	Ecological bicomponent epoxy (medium thickness 150 µm)
Set of standard mechanical seals	Two silicon carbide mechanical seals (2SiC)

Operating limits

Maximum operating temperature	40 °C
PH of treated fluid	6 ÷ 14
Viscosity of treated fluid	1 mm ² /s
Maximum immersion depth	20 m
Density of treated fluid	1 Kg/dm ³
Maximum acoustic pressure	70 dB
max starts per hour	30

DGN



Cooling system

Dry installation available using the cooling jacket (see details to page 17)

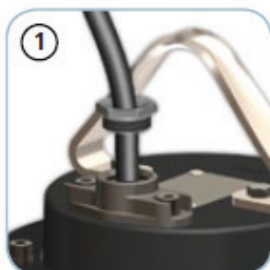

Cable Gland

Cable gland system to guarantee perfect water-tightness. The GAS thread ring-nut can be removed to fix a rigid or flexible duct to the cable gland to protect the power supply cable.



Mechanical seals

Two silicon carbide (2SiC) mechanical seals in oil sump.

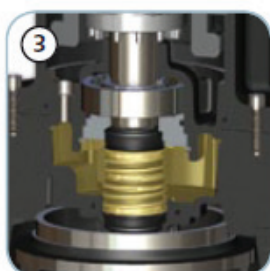

Oil sump

Large oil sump to guarantee longer mechanical seal lifetime. A threaded flange can be easily removed to replace the mechanical seals.



Drive shaft

Impeller connected to the drive shaft by means of tapered coupling.



Free passage

Wide free passage allowing the expulsion of solids and preventing fouling of the impeller.

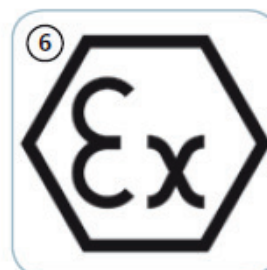

EX

Models available on request with ATEX certification, suitable for installation in the presence of potentially explosive gases, powders and liquids.

CE 0496 Ex II 2GD Ex db k c IIB T5 Ex tb IIIC T100°C IP68

DGN

Models with vertical GAS 2½" threaded discharge - 2 poles

Performances

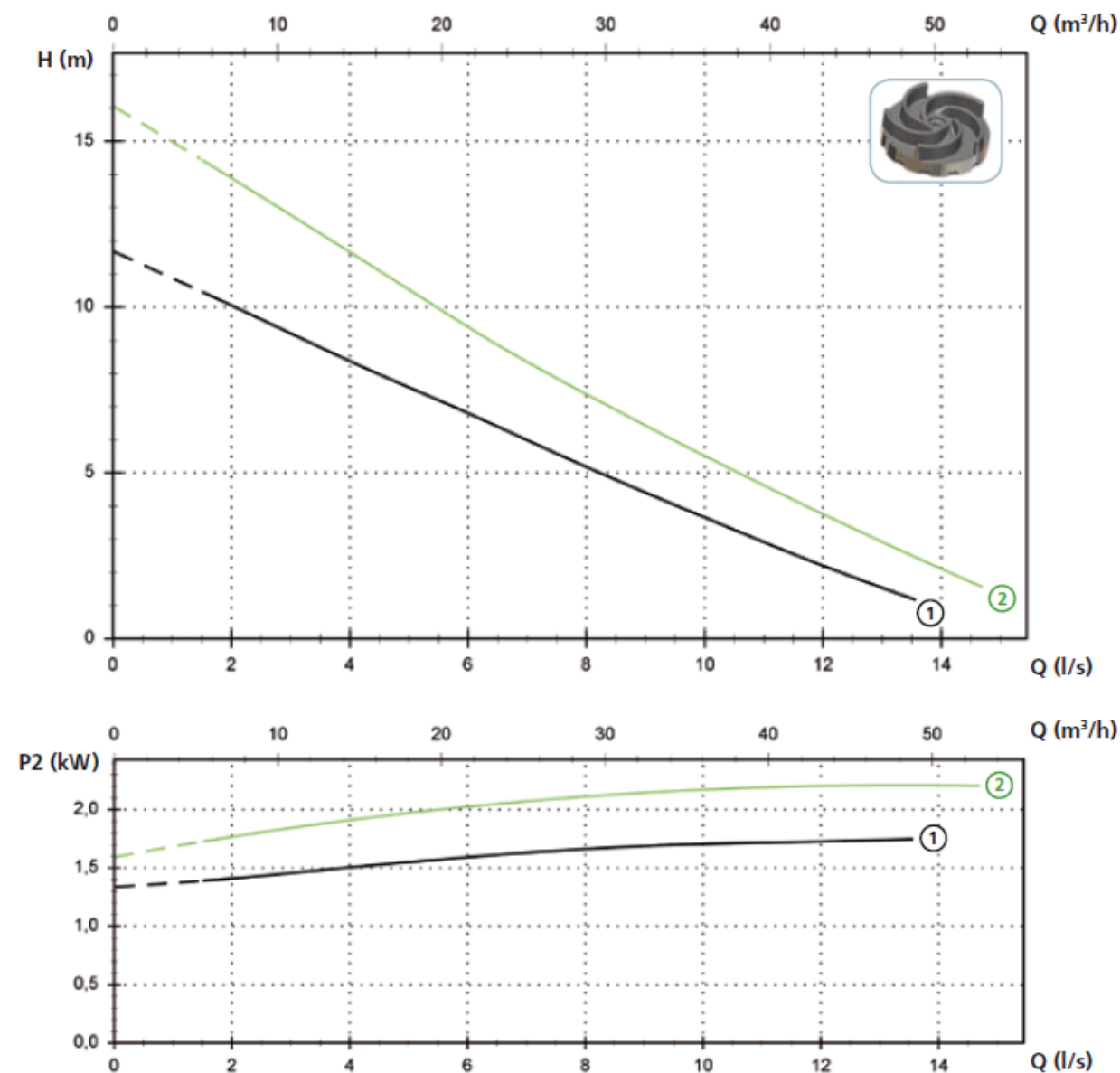

Technical data

	V	Phases	P1 (kW)	P2 (kW)	A	Rpm	Start	∅	Cable (*)	Free passage
① DGN 250/2/G65V A1DM/50	230	1	2.8	1.8	12.5	2900	Dir	G 2½"	A - B	65 mm
① DGN 250/2/G65V A1DT/50	400	3	2.5	1.8	4.3	2900	Dir	G 2½"	A - B	65 mm
② DGN 300/2/G65V A1DT/50	400	3	2.9	2.2	5.1	2900	Dir	G 2½"	A - B	65 mm

(*) A = 07RN-F 4G1.5+3x1 - 10 m (standard version). Electrical and mechanical features are equal to the cable H07RN-F
 B = NSSHOU-J 4G1.5+2x0.75 - 10 m (ATEX version)

Models with horizontal DN65 PN10-16 flanged discharge - 2 poles

Performances

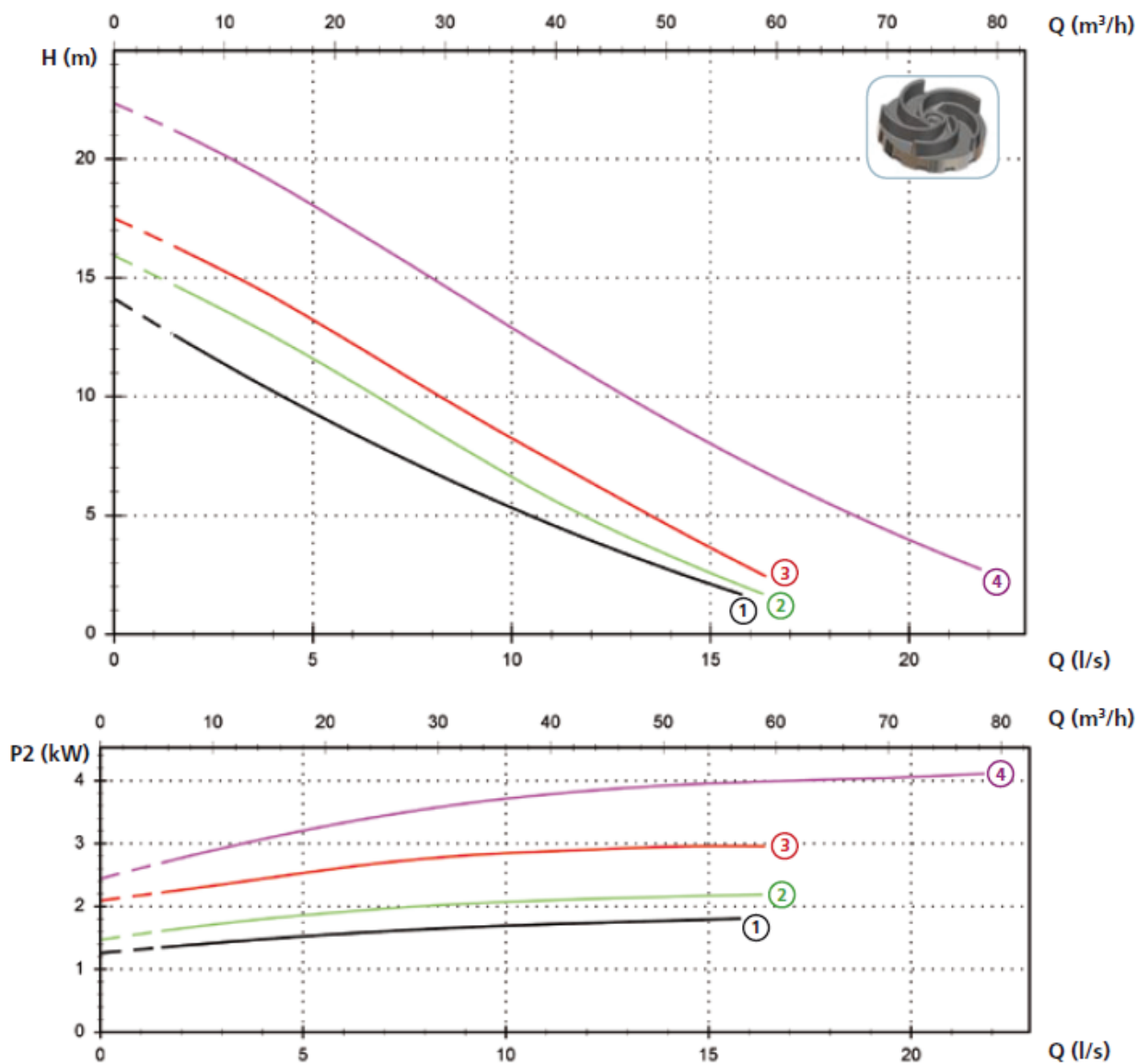

Technical data

	V	Phases	P1 (kW)	P2 (kW)	A	Rpm	Start	Ø	Cable (*)	Free passage
① DGN 250/2/65 A1DM/50	230	1	2.8	1.8	12.5	2900	Dir	DN65 PN10-16	A - B	65 mm
① DGN 250/2/65 A1DT/50	400	3	2.5	1.8	4.3	2900	Dir	DN65 PN10-16	A - B	65 mm
② DGN 300/2/65 A1DT/50	400	3	2.9	2.2	5.1	2900	Dir	DN65 PN10-16	A - B	65 mm
③ DGN 400/2/65 A1FT/50	400	3	4.0	3	6.7	2900	Dir	DN65 PN10-16	A - C	65 mm
④ DGN 550/2/65 A1FT/50	400	3	5.0	4.1	8.7	2900	Dir	DN65 PN10-16	A - C	65 mm

(*) A = 07RN-F 4G1.5+3x1 - 10 m (standard version). Electrical and mechanical features are equal to the cable H07RN-F
 B = NSSHOU-J 4G1.5+2x0.75 - 10 m (ATEX version)
 C = NSSHOU-J 4G2.5+2x0.75 - 10 m (ATEX version)

DGN

Models with horizontal DN80 PN10-16 flanged discharge - 2 poles

Performances

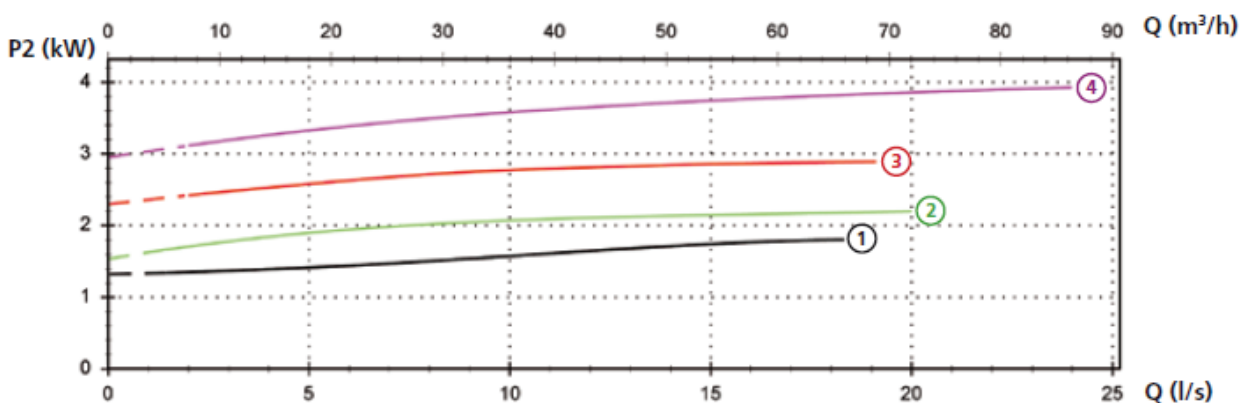
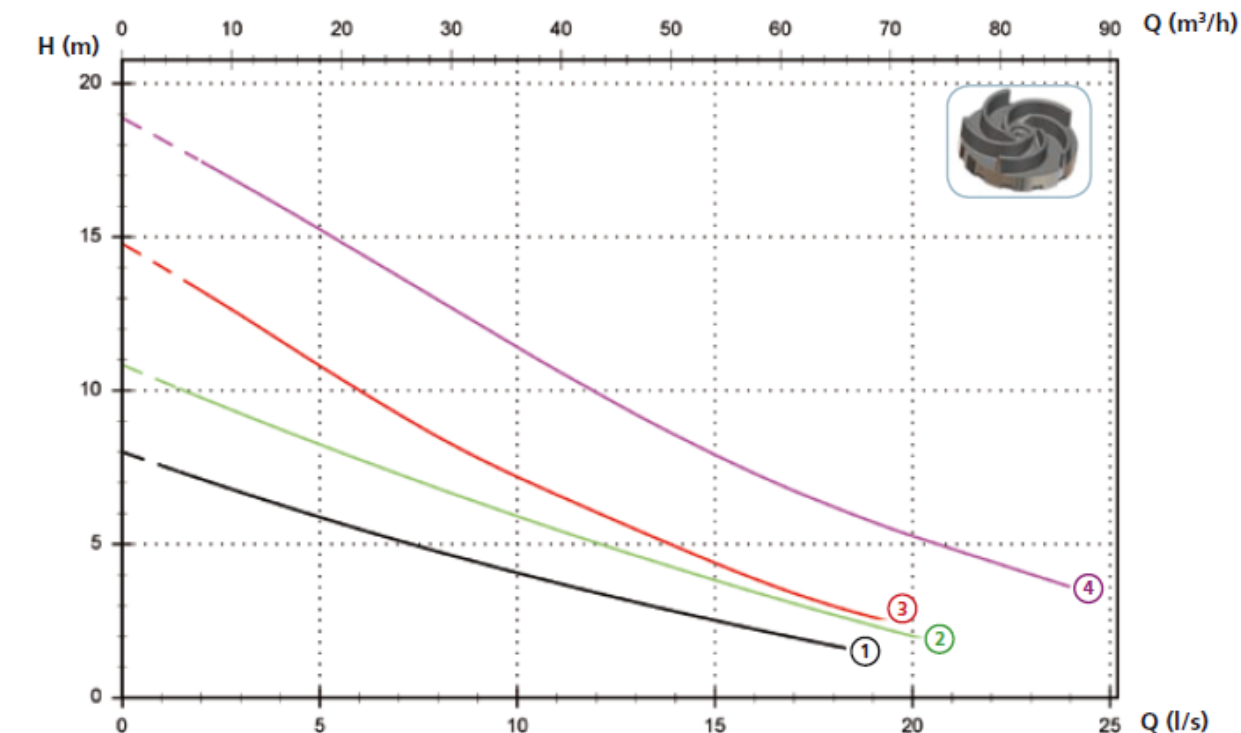

Technical data

	V	Phases	P1 (kW)	P2 (kW)	A	Rpm	Start	∅	Cable (*)	Free passage
① DGN 250/2/80 A1DM/50	230	1	2.8	1.8	12.5	2900	Dir	DN80 PN10-16	A - B	80 mm
① DGN 250/2/80 A1DT/50	400	3	2.5	1.8	4.3	2900	Dir	DN80 PN10-16	A - B	80 mm
② DGN 300/2/80 A1DT/50	400	3	2.9	2.2	5.1	2900	Dir	DN80 PN10-16	A - B	80 mm
③ DGN 400/2/80 A1FT/50	400	3	4.0	3	6.7	2900	Dir	DN80 PN10-16	A - C	80 mm
④ DGN 550/2/80 A1FT/50	400	3	5.0	4.1	8.7	2900	Dir	DN80 PN10-16	A - C	80 mm

(*) A = 07RN-F 4G1.5+3x1 - 10 m (standard version). Electrical and mechanical features are equal to the cable H07RN-F
 B = NSSHOU-J 4G1.5+2x0.75 - 10 m (ATEX version)
 C = NSSHOU-J 4G2.5+2x0.75 - 10 m (ATEX version)

Models with horizontal DN65 PN10-16 flanged discharge - 4 poles

Performances

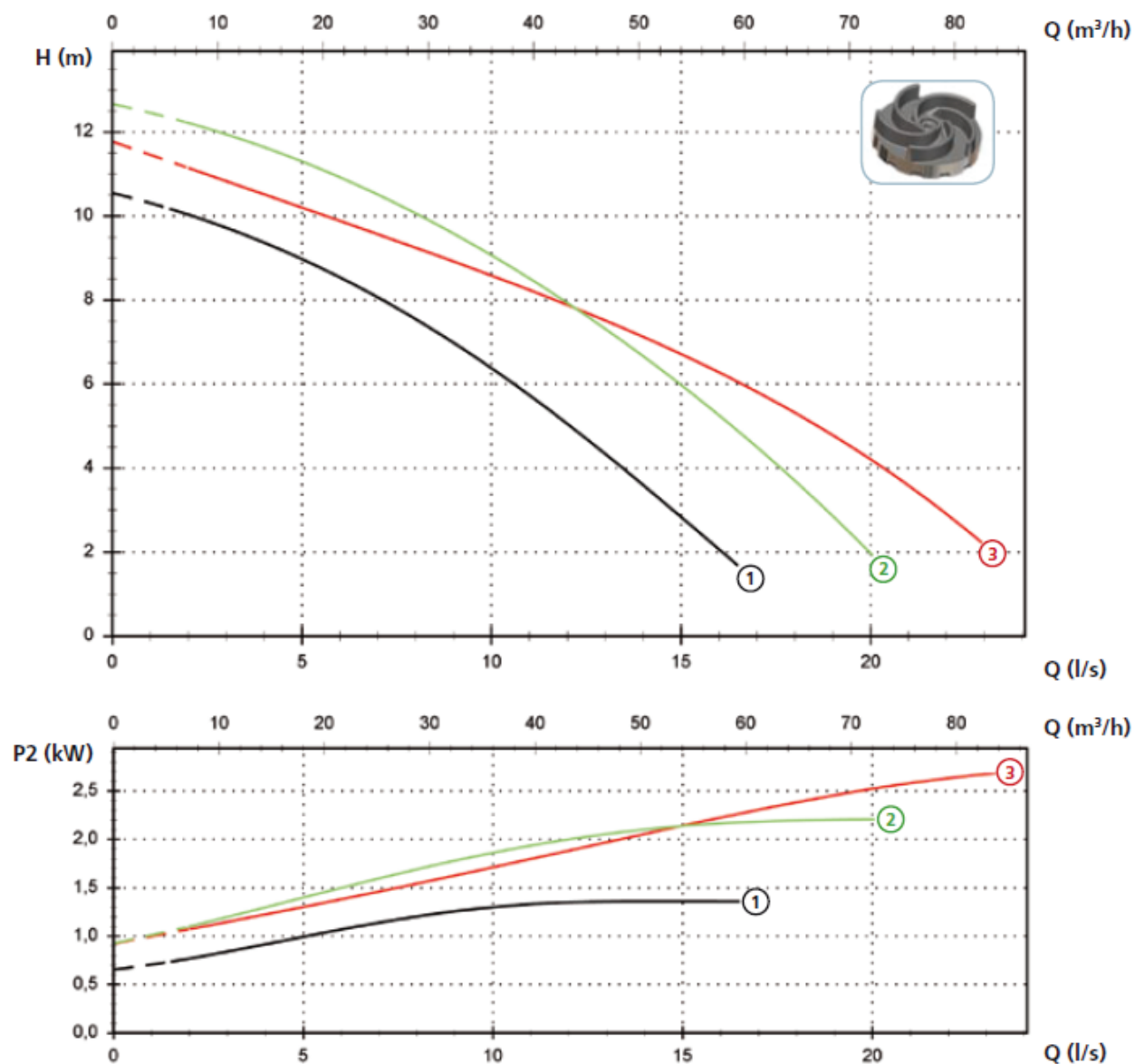

Technical data

	V	Phases	P1 (kW)	P2 (kW)	A	Rpm	Start	Ø	Cable (*)	Free passage	
①	DGN 200/4/65 A1DT/50	400	3	2.0	1.5	4.1	1450	Dir	DN65 PN10-16	A - B	65 mm
②	DGN 300/4/65 A1FT/50	400	3	2.9	2.2	5.8	1450	Dir	DN65 PN10-16	A - C	65 mm
③	DGN 400/4/65 A1FT/50	400	3	3.4	3	6.7	1450	Dir	DN65 PN10-16	A - C	65 mm

(*) A = 07RN-F 4G1.5+3x1 - 10 m (standard version). Electrical and mechanical features are equal to the cable H07RN-F
 B = NSSHOU-J 4G1.5+2x0.75 - 10 m (ATEX version)
 C = NSSHOU-J 4G2.5+2x0.75 - 10 m (ATEX version)

DGN

Models with horizontal DN80 PN10-16 flanged discharge - 4 poles

Performances

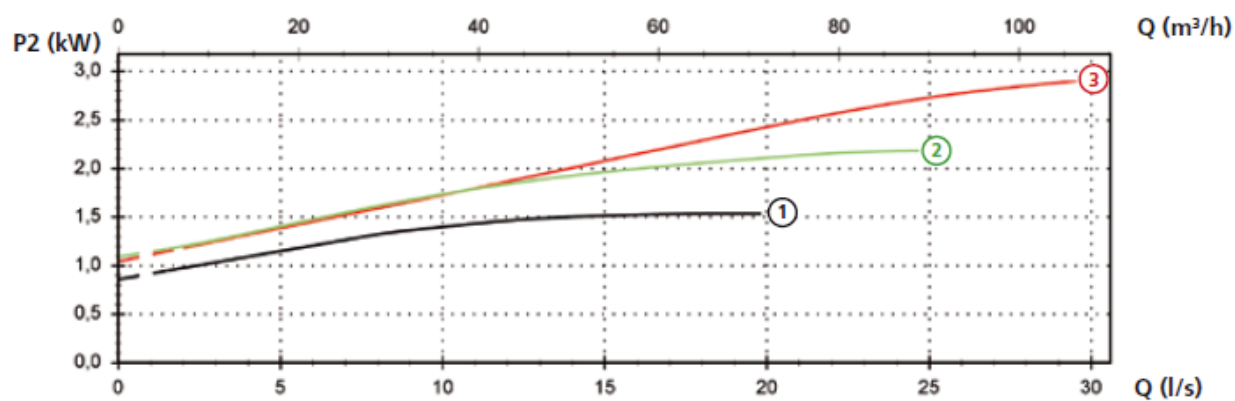
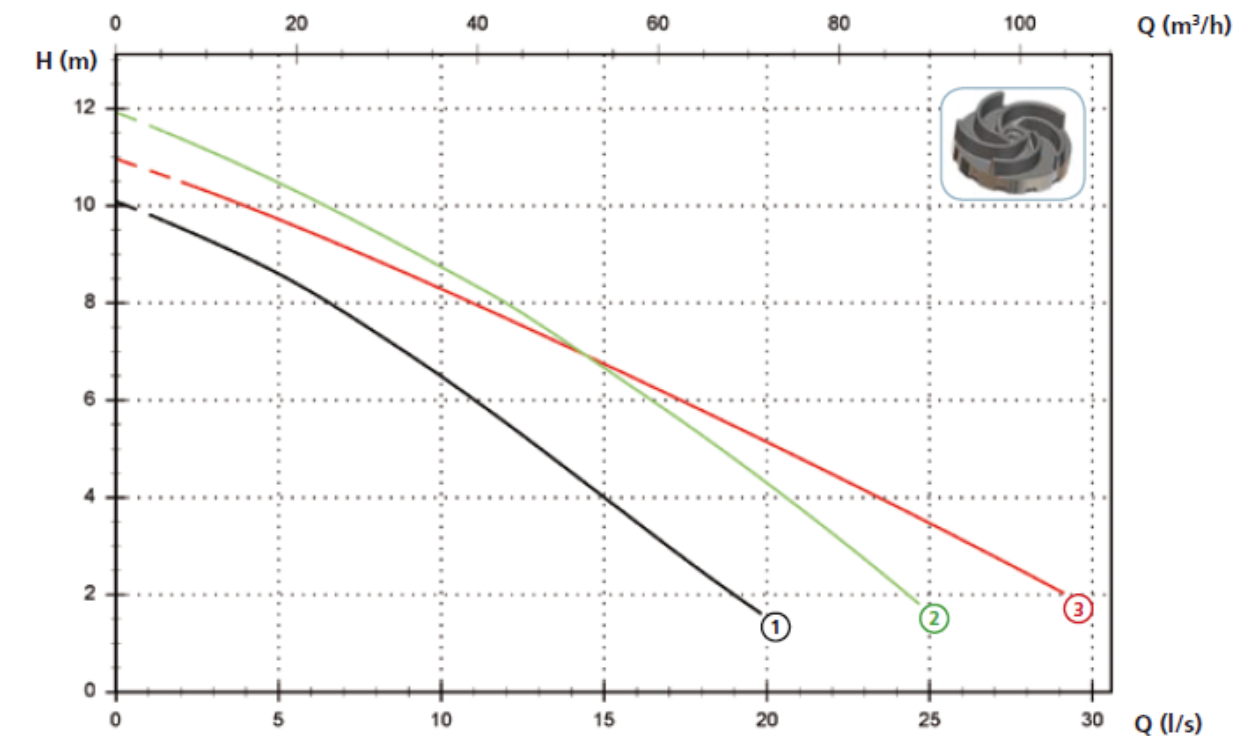

Technical data

	V	Phases	P1 (kW)	P2 (kW)	A	Rpm	Start	Ø	Cable (*)	Free passage
① DGN 200/4/80 A1DT/50	400	3	2.0	1.5	4.1	1450	Dir	DN80 PN10-16	A - B	80 mm
② DGN 300/4/80 A1FT/50	400	3	2.9	2.2	5.8	1450	Dir	DN80 PN10-16	A - C	80 mm
③ DGN 400/4/80 A1FT/50	400	3	3.7	3	7.3	1450	Dir	DN80 PN10-16	A - C	80 mm

(*) A = 07RN-F 4G1.5+3x1 - 10 m (standard version). Electrical and mechanical features are equal to the cable H07RN-F
 B = NSSHOU-J 4G1.5+2x0.75 - 10 m (ATEX version)
 C = NSSHOU-J 4G2.5+2x0.75 - 10 m (ATEX version)

Models with horizontal DN100 PN10-16 flanged discharge - 4 poles

Performances

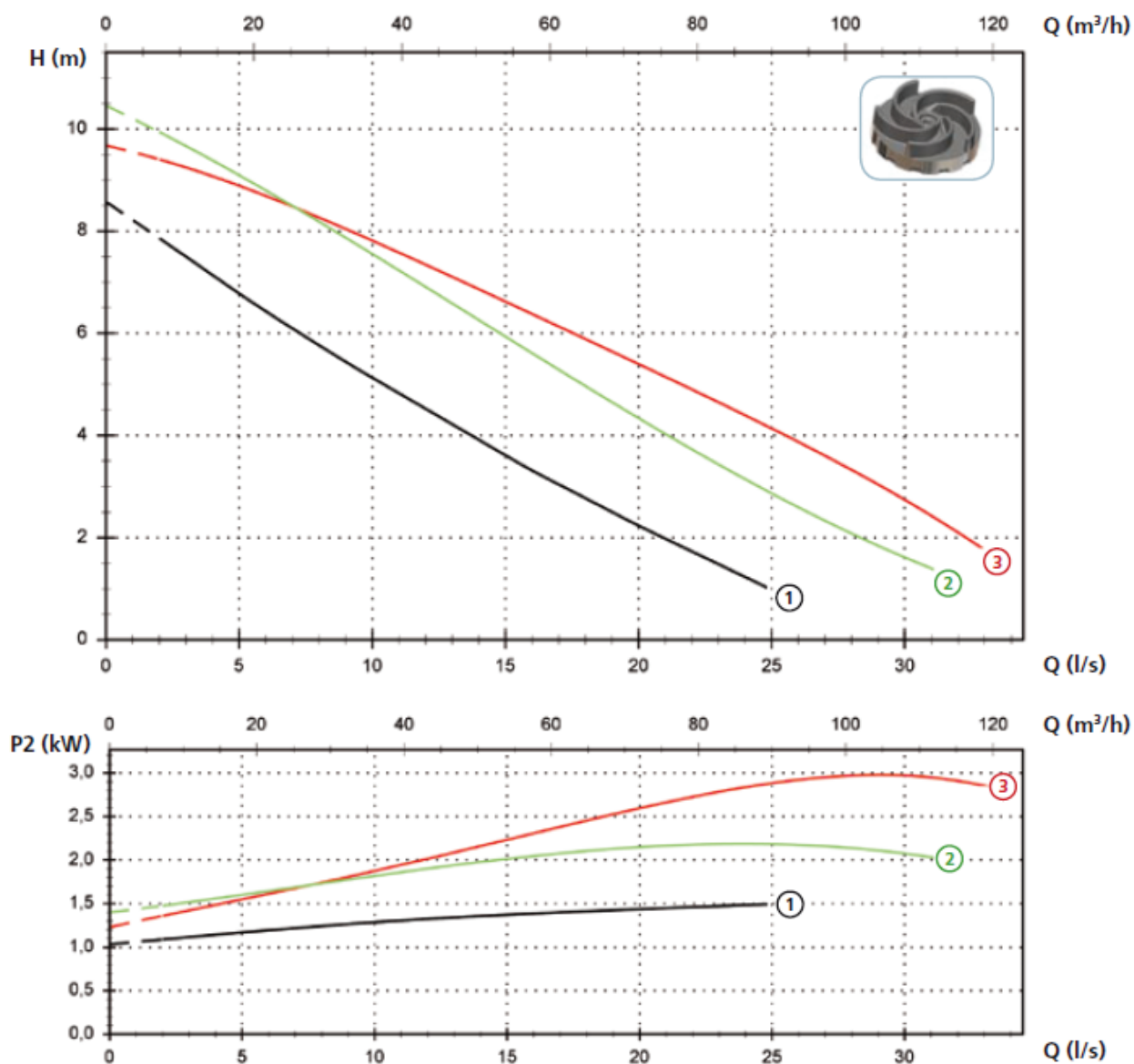

Technical data

	V	Phases	P1 (kW)	P2 (kW)	A	Rpm	Start	Ø	Cable (*)	Free passage	
①	DGN 200/4/100 A1DT/50	400	3	2.0	1.5	4.1	1450	Dir	DN100 PN10-16	A - B	100 mm
②	DGN 300/4/100 A1FT/50	400	3	2.9	2.2	5.8	1450	Dir	DN100 PN10-16	A - C	100 mm
③	DGN 400/4/100 A1FT/50	400	3	3.7	3	7.3	1450	Dir	DN100 PN10-16	A - C	100 mm

(*) A = 07RN-F 4G1.5+3x1 - 10 m (standard version). Electrical and mechanical features are equal to the cable H07RN-F
 B = NSSHOU-J 4G1.5+2x0.75 - 10 m (ATEX version)
 C = NSSHOU-J 4G2.5+2x0.75 - 10 m (ATEX version)

DGN

Models with horizontal DN65 PN10-16 flanged discharge - 6 poles

Performances

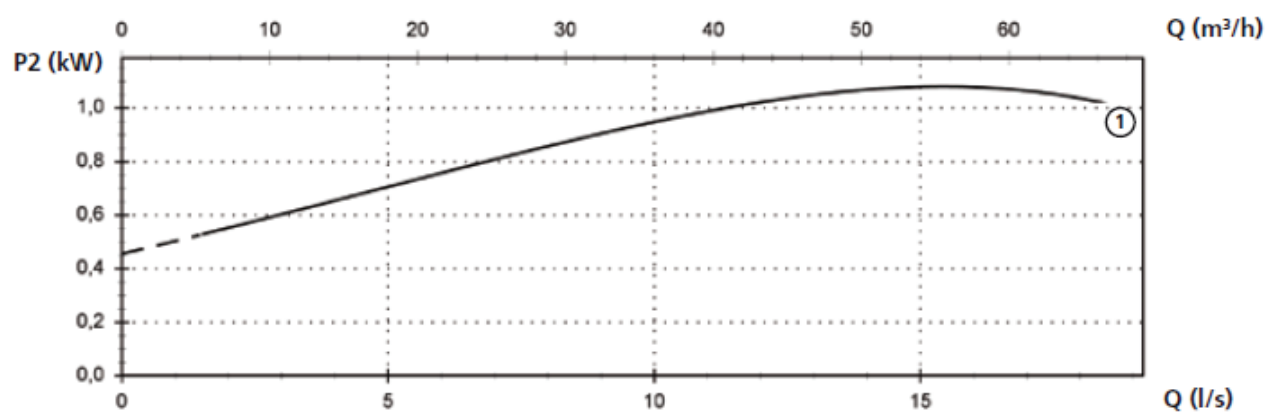
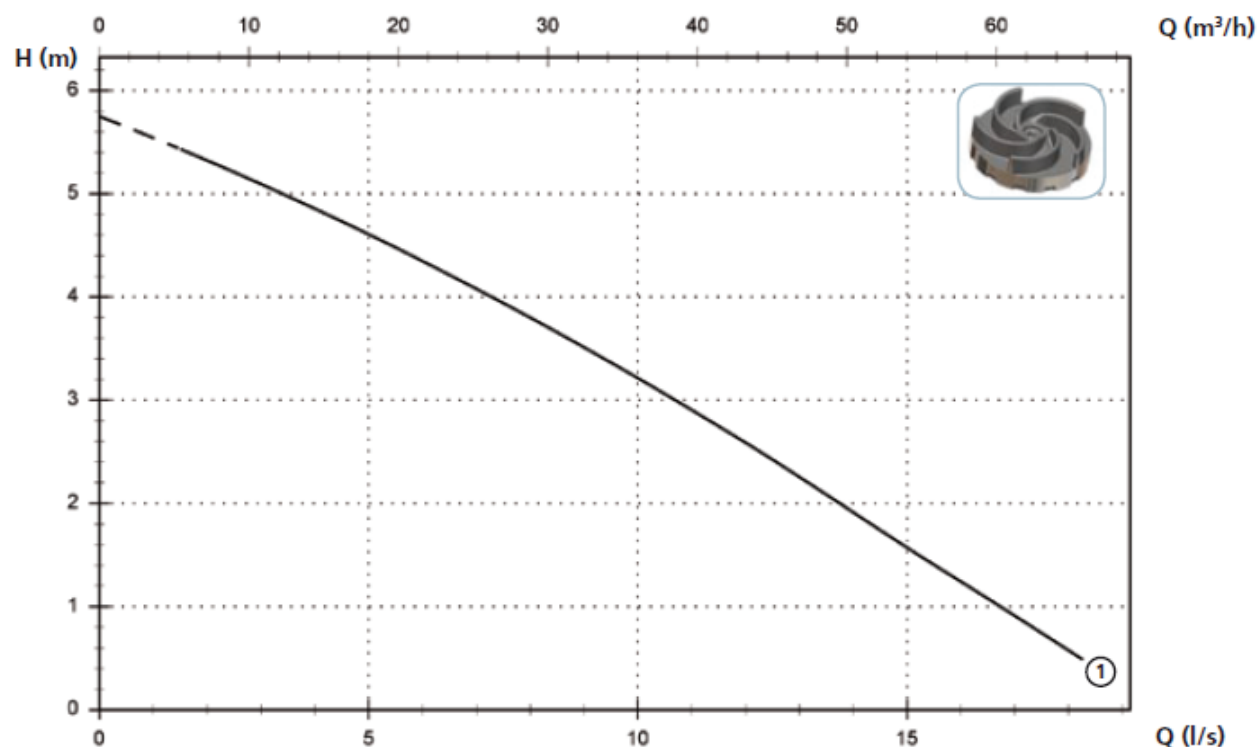

Technical data

	V	Phases	P1 (kW)	P2 (kW)	A	Rpm	Start	Ø	Cable (*)	Free passage
① DGN 150/6/65 A1DT/50	400	3	1.6	1.1	3.7	960	Dir	DN65 PN10-16	A - B	65 mm

(*) A = 07RN-F 4G1.5+3x1 - 10 m (standard version). Electrical and mechanical features are equal to the cable H07RN-F
 B = NSSHOU-J 4G1.5+2x0.75 - 10 m (ATEX version)

Models with horizontal DN80 PN10-16 flanged discharge - 6 poles

Performances

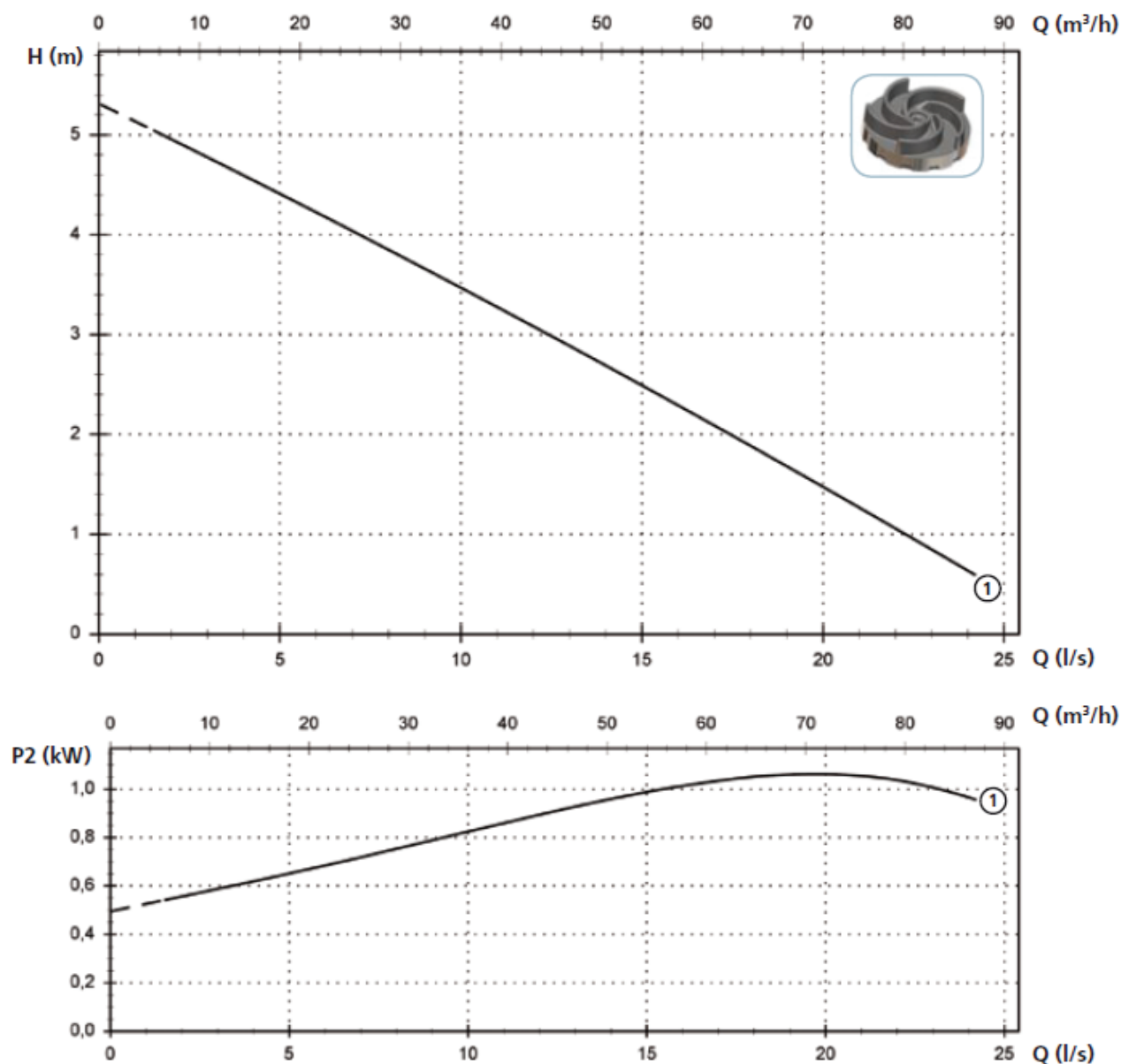

Technical data

	V	Phases	P1 (kW)	P2 (kW)	A	Rpm	Start	Ø	Cable (*)	Free passage	
①	DGN 150/6/80 A1DT/50	400	3	1.6	1.1	3.7	960	Dir	DN80 PN10-16	A - B	80 mm

(*) A = 07RN-F 4G1.5+3x1 - 10 m (standard version). Electrical and mechanical features are equal to the cable H07RN-F
 B = NSSHOU-J 4G1.5+2x0.75 - 10 m (ATEX version)

DGN

Models with horizontal DN100 PN10-16 flanged discharge - 6 poles

Performances

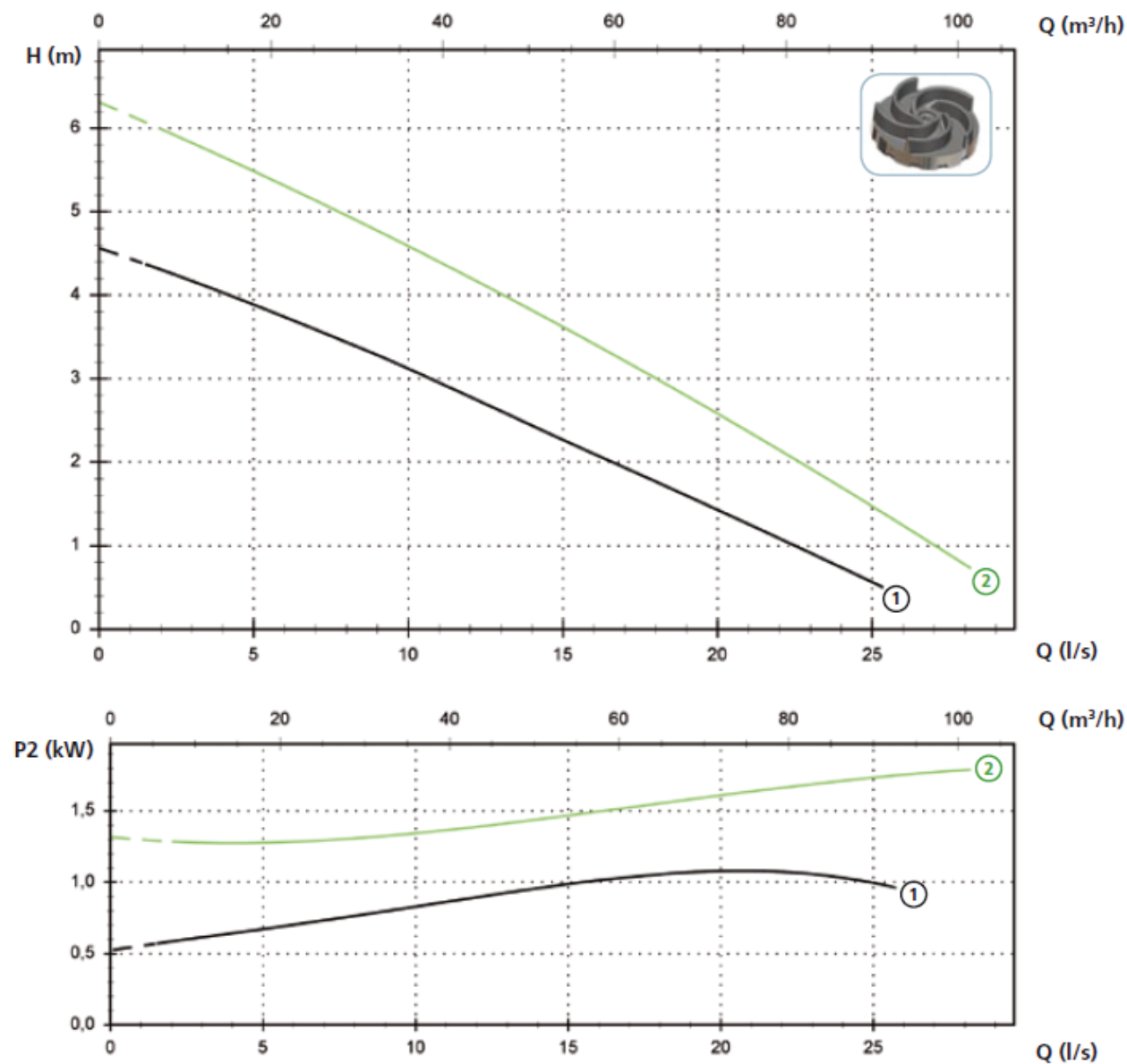

Technical data

	V	Phases	P1 (kW)	P2 (kW)	A	Rpm	Start	Ø	Cable (*)	Free passage	
①	DGN 150/6/100 A1DT/50	400	3	1.6	1.1	3.7	960	Dir	DN100 PN10-16	A - B	100 mm
②	DGN 250/6/100 A1FT/50	400	3	2.6	1.8	5.7	960	Dir	DN100 PN10-16	A - C	100 mm

(*) A = 07RN-F 4G1.5+3x1 - 10 m (standard version). Electrical and mechanical features are equal to the cable H07RN-F
 B = NSSHOU-J 4G1.5+2x0.75 - 10 m (ATEX version)
 C = NSSHOU-J 4G2.5+2x0.75 - 10 m (ATEX version)

Models with horizontal DN150 PN10-16 flanged discharge - 6 poles

Performances

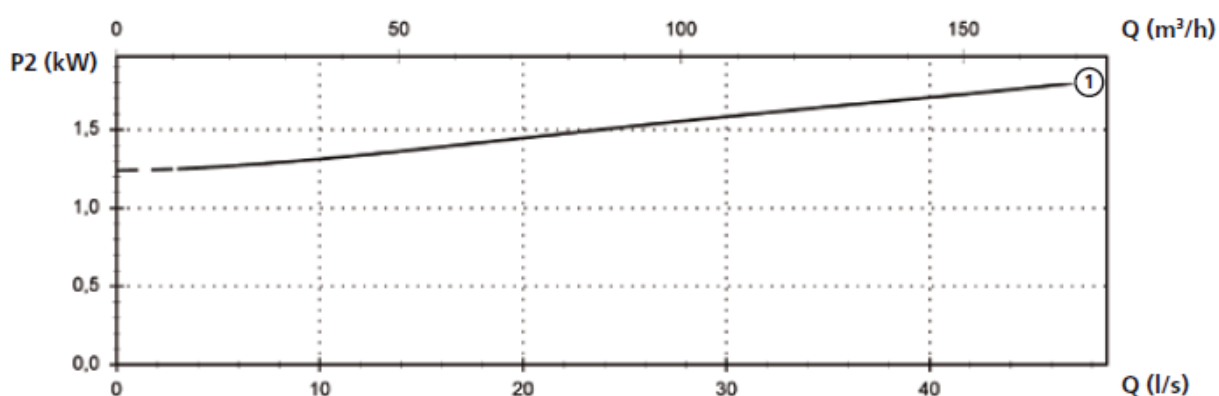
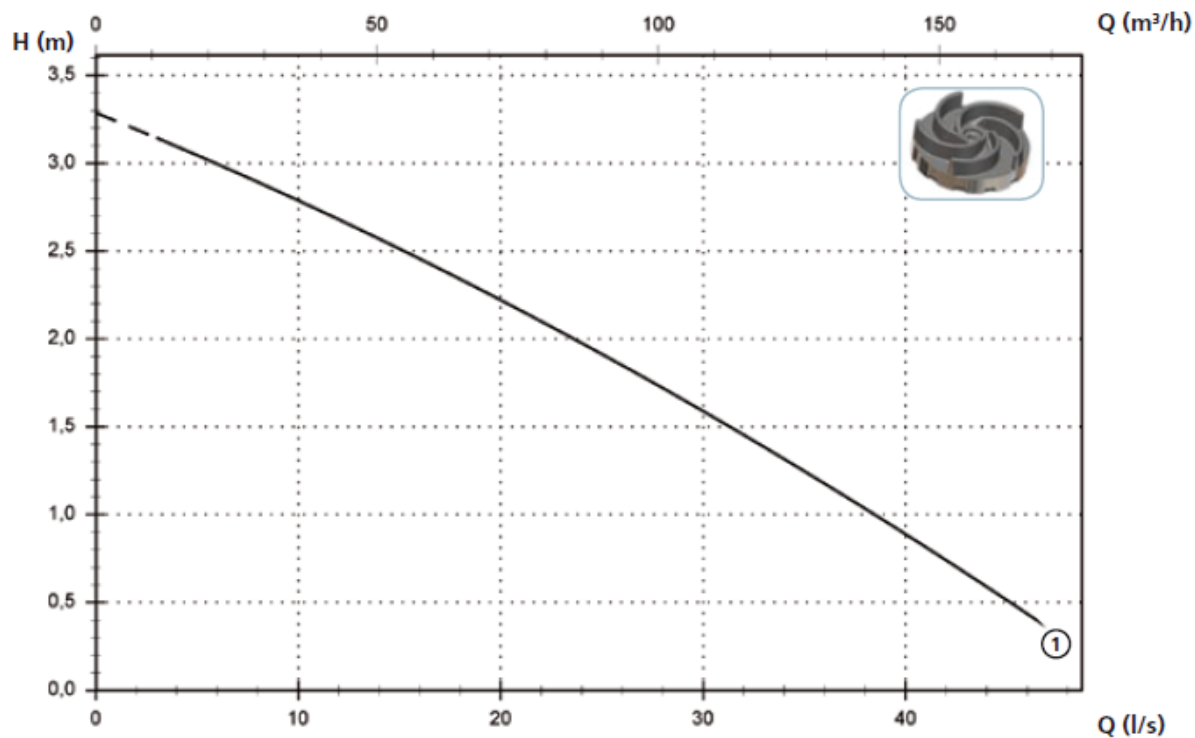

Technical data

	V	Phases	P1 (kW)	P2 (kW)	A	Rpm	Start	∅	Cable (*)	Free passage	
①	DGN 250/6/150 A1FT/50	400	3	2.6	1.8	5.7	960	Dir	DN150 PN10-16	A - B	150 mm

(*) A = 07RN-F 4G1.5+3x1 - 10 m (standard version). Electrical and mechanical features are equal to the cable H07RN-F
 B = NSSHOU-J 4G2.5+2x0.75 - 10 m (ATEX version)

DGN

Versions available

(Key to versions on page 16)

	Electrical variants											Cooling				Mechanical seals				
	N A E	T	T C	T C D	T C D T	T C D G T	T C G	T C S T	T C S G T	T S	T R	T R G	N	CC CCE	FT	C G F T	2SIC	SICM	SICAL	2SICAL
DGN 250/2/G65V A1DM/50				●								●	●			●				
DGN 250/2/G65V A1DT/50		●								●		●	●			●				
DGN 300/2/G65V A1DT/50		●								●		●	●			●				
DGN 250/2/65 A1DM/50				●								●	●			●				
DGN 250/2/65 A1DT/50		●								●		●	●			●				
DGN 300/2/65 A1DT/50		●								●		●	●			●				
DGN 400/2/65 A1FT/50		●								●		●	●			●				
DGN 550/2/65 A1FT/50		●								●		●	●			●				
DGN 250/2/80 A1DM/50				●								●	●			●				
DGN 250/2/80 A1DT/50		●								●		●	●			●				
DGN 300/2/80 A1DT/50		●								●		●	●			●				
DGN 400/2/80 A1FT/50		●								●		●	●			●				
DGN 550/2/80 A1FT/50		●								●		●	●			●				
DGN 200/4/65 A1DT/50		●								●		●	●			●				
DGN 300/4/65 A1FT/50		●								●		●	●			●				
DGN 400/4/65 A1FT/50		●								●		●	●			●				
DGN 200/4/80 A1DT/50		●								●		●	●			●				
DGN 300/4/80 A1FT/50		●								●		●	●			●				
DGN 400/4/80 A1FT/50		●								●		●	●			●				
DGN 200/4/100 A1DT/50		●								●		●	●			●				
DGN 300/4/100 A1FT/50		●								●		●	●			●				
DGN 400/4/100 A1FT/50		●								●		●	●			●				
DGN 150/6/65 A1DT/50		●								●		●	●			●				
DGN 150/6/80 A1DT/50		●								●		●	●			●				
DGN 150/6/100 A1DT/50		●								●		●	●			●				
DGN 250/6/100 A1FT/50		●								●		●	●			●				
DGN 250/6/150 A1FT/50		●								●		●	●			●				

NOTE FOR SINGLE PHASE PUMPS: thermal protections into the winding have to be connected to the electrical panel.
 Start capacitor inside the pump. Circuit breaker supplied but not connected to the pump cable.
 The use of an electrical panel as circuit breaker housing is mandatory.
 For installation please see use and maintenance instructions booklet.

Overall dimensions and weights

Models with vertical discharge

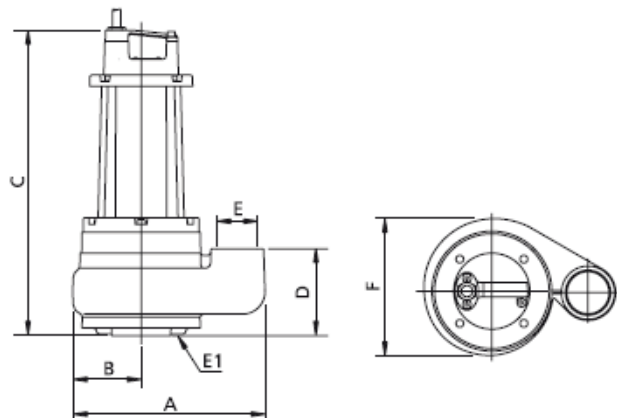

Models with horizontal discharge

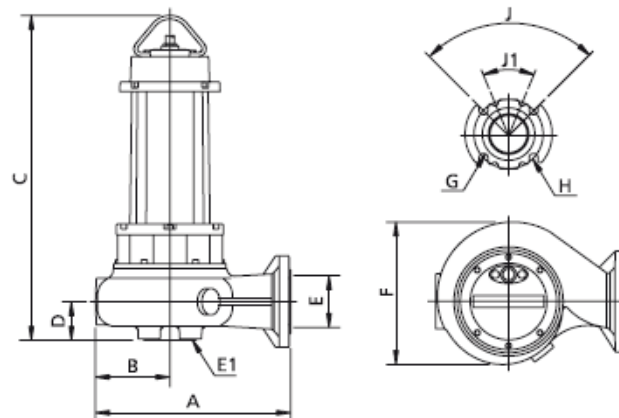

	A	B	C	D	E	E1 (*)	F	G	H	J	J1	kg
DGN 250/2/G65V A1DM(T)/50	310	110	560	135	G 2½"	65	220	-	-	-	-	49
DGN 300/2/G65V A1DT/50	310	110	560	135	G 2½"	65	220	-	-	-	-	51
DGN 250/2/65 A1DM(T)/50	300	120	560	60	65	65	220	18	145	90°	-	51
DGN 300/2/65 A1DT/50	320	130	580	80	65	65	250	18	145	90°	-	53
DGN 400/2/65 A1FT/50	320	130	720	80	65	65	250	18	145	90°	-	74
DGN 550/2/65 A1FT/50	320	130	720	80	65	65	250	18	145	90°	-	78
DGN 250/2/80 A1DM(T)/50	310	120	585	80	80	80	230	18	160	90°	45°	53
DGN 300/2/80 A1DT/50	315	125	585	80	80	80	245	18	160	90°	45°	55
DGN 400/2/80 A1FT/50	315	125	725	80	80	80	245	18	160	90°	45°	75
DGN 550/2/80 A1FT/50	315	125	725	80	80	80	245	18	160	90°	45°	79
DGN 200/4/65 A1DT/50	390	155	595	70	65	65	305	18	145	90°	-	63
DGN 300/4/65 A1FT/50	390	155	700	70	65	65	305	18	145	90°	-	78
DGN 400/4/65 A1FT/50	390	155	700	70	65	65	305	18	145	90°	-	82
DGN 200/4/80 A1DT/50	385	155	610	80	80	80	300	18	160	90°	45°	64
DGN 300/4/80 A1FT/50	385	155	720	80	80	80	300	18	160	90°	45°	79
DGN 400/4/80 A1FT/50	385	155	720	80	80	80	300	18	160	90°	45°	83
DGN 200/4/100 A1DT/50	410	160	635	90	100	100	305	18	180	45°	-	66
DGN 300/4/100 A1FT/50	410	160	740	90	100	100	305	18	180	45°	-	81
DGN 400/4/100 A1FT/50	410	160	740	90	100	100	305	18	180	45°	-	85
DGN 150/6/65 A1DT/50	390	155	595	70	65	65	305	18	145	90°	-	61
DGN 150/6/80 A1DT/50	385	155	610	80	80	80	300	18	160	90°	45°	62
DGN 150/6/100 A1DT/50	410	160	635	90	100	100	305	18	180	45°	-	66
DGN 250/6/100 A1FT/50	495	190	770	90	100	100	375	18	180	45°	-	111
DGN 250/6/150 A1FT/50	550	215	825	120	150	150	400	24	240	45°	-	114

Dimensions in mm

All weights and dimensions are indicative only

(*) DN of the suction flange - PN6

DGN

Packaging dimension

	A	B	C
DGN 250/2/G65V A1DM(T)/50	725	555	415
DGN 300/2/G65V A1DT/50	725	555	415
DGN 250/2/65 A1DM(T)/50	725	555	415
DGN 300/2/65 A1DT/50	725	555	415
DGN 400/2/65 A1FT/50	915	515	555
DGN 550/2/65 A1FT/50	915	515	555
DGN 250/2/80 A1DM(T)/50	725	445	415
DGN 300/2/80 A1DT/50	725	445	415
DGN 400/2/80 A1FT/50	915	515	555
DGN 550/2/80 A1FT/50	915	515	555
DGN 200/4/65 A1DT/50	725	445	415
DGN 300/4/65 A1FT/50	915	515	555
DGN 400/4/65 A1FT/50	915	515	555
DGN 200/4/80 A1DT/50	725	445	415
DGN 300/4/80 A1FT/50	915	515	555
DGN 400/4/80 A1FT/50	915	515	555
DGN 200/4/100 A1DT/50	725	445	415
DGN 300/4/100 A1FT/50	915	515	555
DGN 400/4/100 A1FT/50	915	515	555
DGN 150/6/65 A1DT/50	915	515	555
DGN 150/6/80 A1DT/50	915	515	555
DGN 150/6/100 A1DT/50	915	515	555
DGN 250/6/100 A1FT/50	915	515	555
DGN 250/6/150 A1FT/50	915	515	555

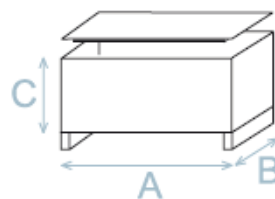

Dimension in mm

All weights and dimensions are indicative only

Installations available

